

DADCO®

Nitrogen Gas Spring Linked System Components



Everything You Need to Construct a Linked System

Numerous Piping Options

Many customers recognize the benefits of linking nitrogen gas springs; linked systems allow users to easily monitor, control and adjust pressure from outside the die. In this catalog DADCO has brought together all of the components necessary to easily configure a linked system. Choose from the various types of fittings, hose, control panels and specialty components to design a linked system best suited for your application.

DADCO also offers ready-to-install complete linked systems built to customer specifications.

Complete Linked Systems from DADCO SMS®

For those instances where a customer prefers to have DADCO provide a finished system, DADCO offers several options. First is the Sectional Mounting System (SMS®) where DADCO will mount cylinders to a SMS® plate and link them using hose, fittings and a control panel based on a customer design. For more information on DADCO's SMS® request catalog C13106B.

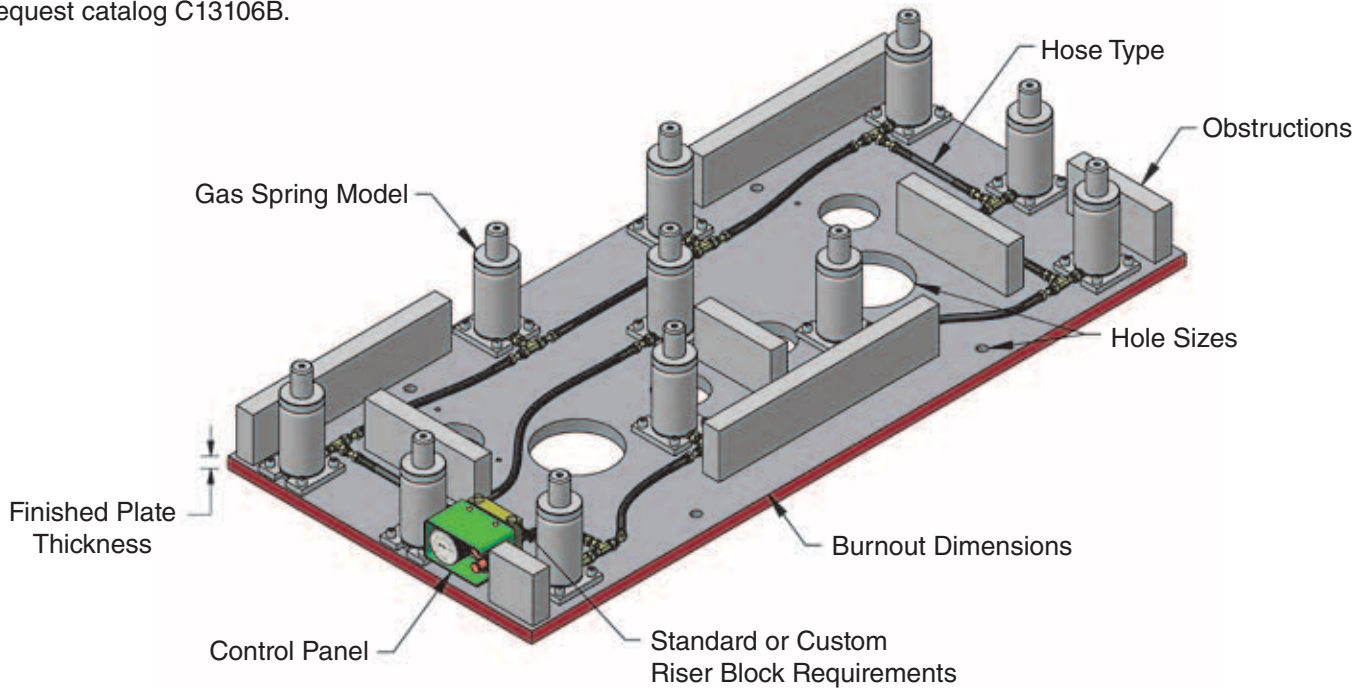

SMS-i®

Another option, which is new from DADCO, is the Sectional Mounting System - Internal (SMS-i®). DADCO will mount cylinders to a plate that has been piped internally. DADCO recommends using the SMS-i® as an alternative to traditional manifold systems. For more information on DADCO's SMS-i® request catalog C13106B.

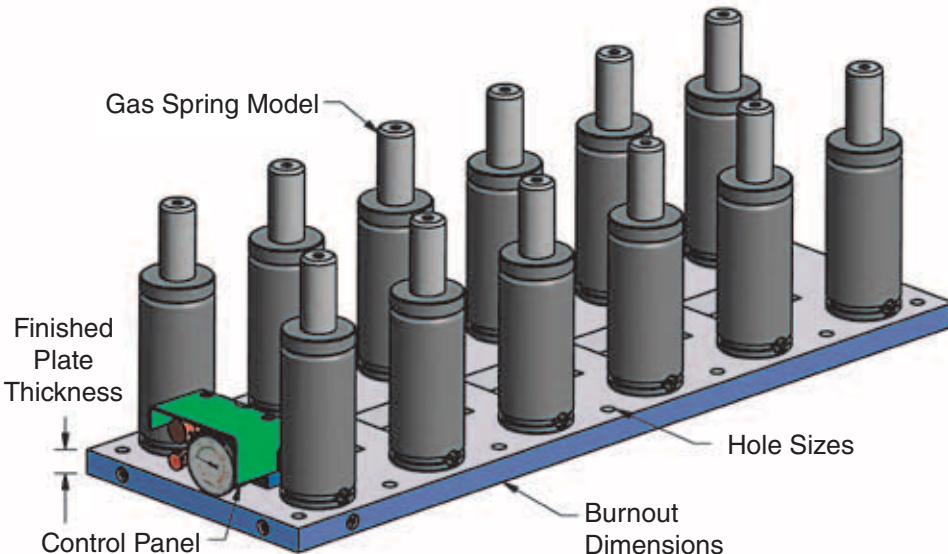

SMS-i® Connection

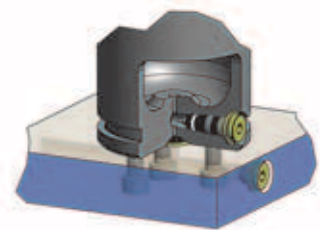

DADCO gas springs used in a SMS-i® have a bottom port and are attached to the base plate with a sealing washer and standard mounting hardware.

Overview

DADCO Gas Springs are grouped by two main classifications: Mini Springs with a M6 Port and Large Springs with a G 1/8 BSPP Port. DADCO recommends choosing control panels, fittings and hose type based on port style and application requirements.

Port Style

M6 Mini Port



Gas Springs with M6 Port:

- Micro Series
- U.0175 – U.2600
- LJ and L Series
- SCR Series
- FCL Series
- 90.10.00170

G 1/8 Large Port



Gas Springs with G 1/8 Port:

- U.4600 – U.20000
- UH Series
- UX Series
- 90.8 Series
- 90.10.00500 – 90.10.10000
- SC Series



Compatible Fitting Styles

Preferred

DADCO MINILink®
(M8 x 1)



See page 16

D-24 Tapered
(M12 x 1.5)



See page 15

Zip (CNOMO)
(S12.65 x 1.5)



See page 17

Preferred

O-Ring Face Seal (ORFS)
(9/16-18)



See pages 12-14

Hose System

90.700 (Y-700) Hose
90.705 (Y-705) Hose

Preferred



See page 11

90.500 (Y-500) Hose

Preferred



See page 11

90.400 (Y-400) Hose



See page 11

90.250 (Y-250) Hose



See page 11

Linked Operations

Converting from Self-Contained to Linked Mode

The following basic steps show how to easily convert DADCO gas springs from self-contained to linked mode. For more detailed instructions, refer to the relevant product catalog. (*Mini series gas spring with M6 port shown below.*)

CAUTION
Always wear safety goggles when performing maintenance on nitrogen gas springs.

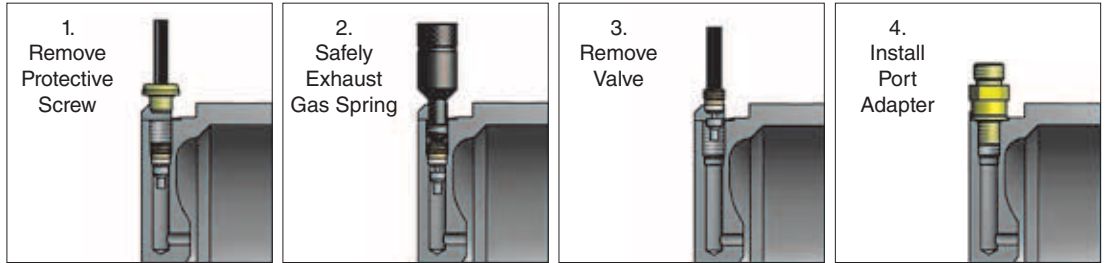

Recommendations for Linked Systems

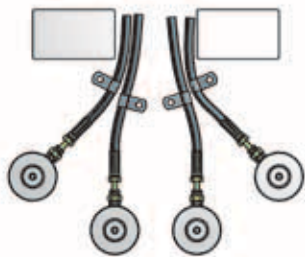

Allow ample space to secure hoses to plate. It is preferred that hoses rest side by side.

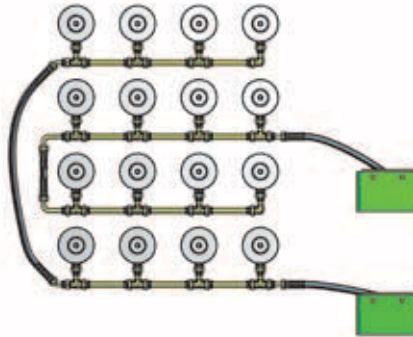

Arrange gas springs to provide uniformity and balance within the die. Use multiple panels for large systems to allow faster filling and discharging.

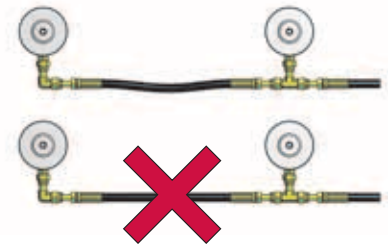

When linking cylinders allow for ample hose to avoid taut connections.

Torque Specifications

Tighten fittings to the following torque specifications to prevent damage and loosening from vibration during operation.

Type	Thread	lb-in	lb-ft	N-m
M6 Port Adapter	M6 x 1	25	2.1	3
MINILink® Hose Adapter	M8 x 1	25	2.1	3
G 1/8 Port Adapter	BSPP	168	14	19
ORFS Hose Adapter	9/16-18	204	17	23
D-24 Hose Adapter	M12 x 1.5	Hand-tight then ¼ turn with wrench		
Zip Hose Adapter	S12.65 x 1.5	Hand-tight		

Use two wrenches, one on the port adapter and one on the hose adapter, to avoid over-tightening. The drawings below depict the importance of torque specifications in common port and hose adapter combinations.

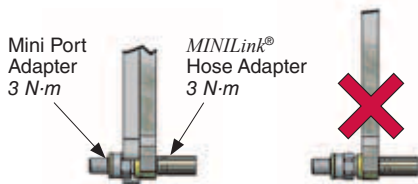

Mini Port Adapter + MINILink® Hose Adapter
Mini fittings and hose adapters have low torque values. Refer to the chart above to avoid possible damage from over-tightening.

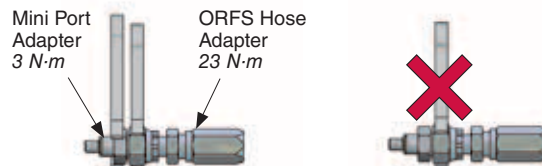

Mini Port Adapter + 9/16-18 ORFS Hose Adapter
The torque requirement for the Mini Port Adapter is smaller than the ORFS Hose Adapter. Refer to the chart above. Do not torque port fitting with larger hose adapter nut.

NOTE: It is important to adhere to these guidelines for the following fittings: 90.505.116 and 90.508.116.

Components: Control Panels

Convertible Control Panel



The DADCO Convertible Control Panel is used to fill, drain and monitor the pressure of linked DADCO nitrogen gas springs from outside the die. The panel consists of four G 1/8 BSPP ports, a high pressure 63 mm diameter gauge, a quick disconnect fill valve, a bleed valve and a rupture disk to prevent overpressurization. For maximum versatility, the panel is available with a variety of fitting connections. See below for information on the riser blocks available for use with the control panel.

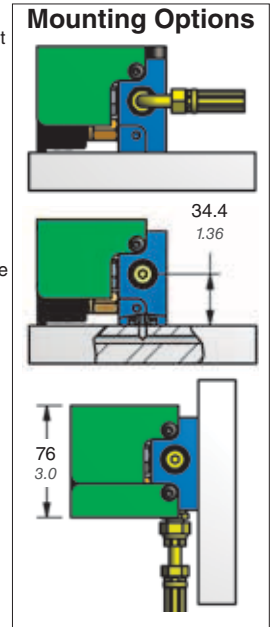
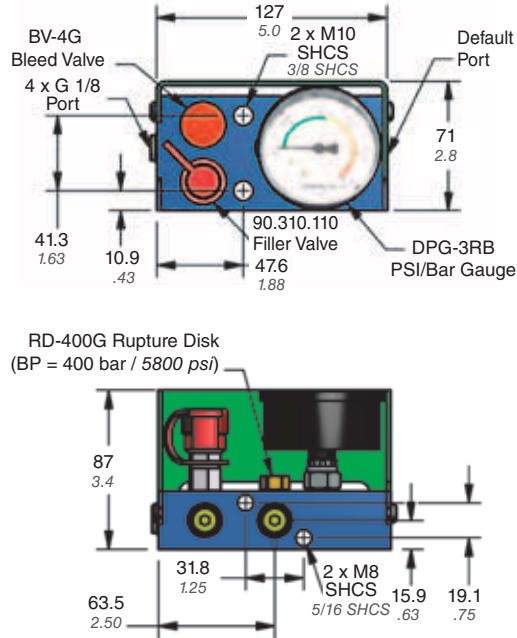
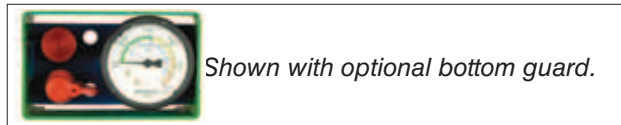

Ordering Example:

90.406. P 1 N

Common Control Panel

Gauge Style

PSI/Bar Gauge (DPG-3RB) = P
 Bar/MPa Gauge (DPG-3RM) = A
 When not specified, default is P.

Guard

Top Guard = 1
 Top and Bottom Guards = 2
 When not specified, default is 1.

Fitting Connection

N = No Fitting Supplied,
 M = Manifold Seal,
 S = ORFS Fitting,
 D = D-24 Fitting,
 B = Zip Fitting,
 L = MINILink® Fitting
 When not specified, default is N.

NOTE: The 90.406.P2S is a direct replacement of DADCO's 90.406.03.

Riser Block for Convertible Control Panel

DADCO offers the 90.406.220, 90.406.555, and the 90.406.758 Riser Blocks for use with the Convertible Control Panel for maximum mounting versatility. It allows for easy mounting of the Control Panel to SMS® plates.

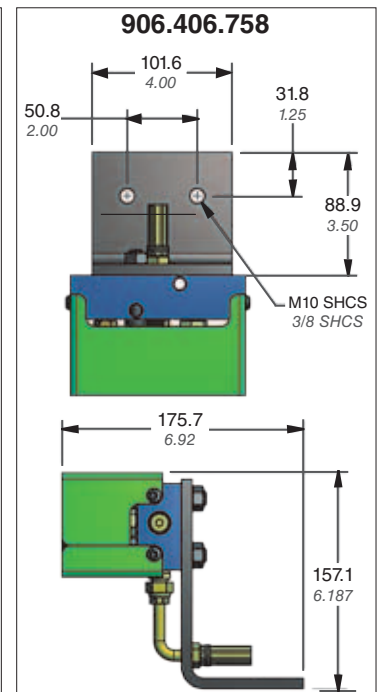
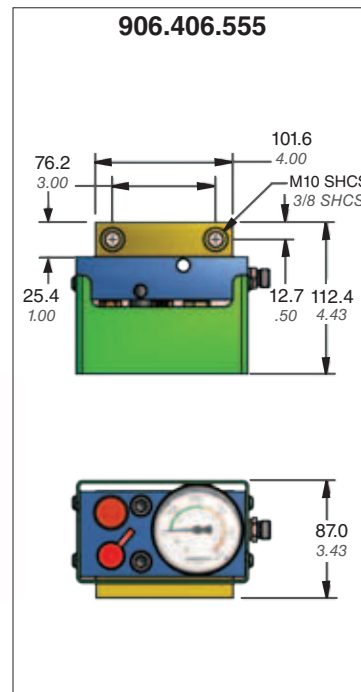
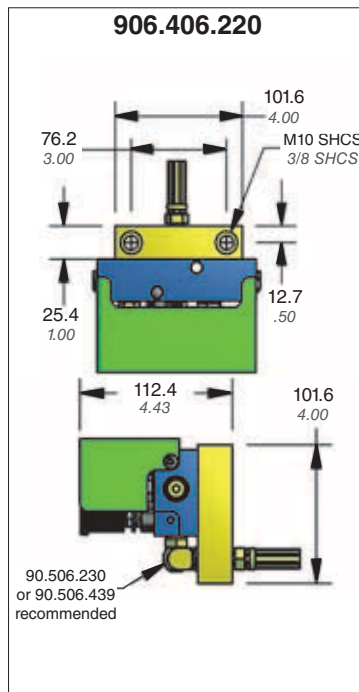
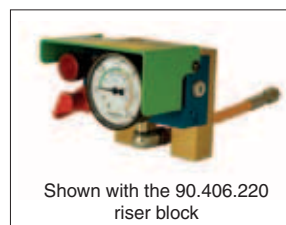

Common Control Panel



The DADCO Common Control Panel is used to fill and monitor the pressure of linked DADCO Nitrogen Gas Springs from outside the die. The panel consists of a high pressure gauge (MPa and bar), quick disconnect fill valve, and a rupture disk to prevent overpressurization. This Control Panel conforms to the Toyota standard.

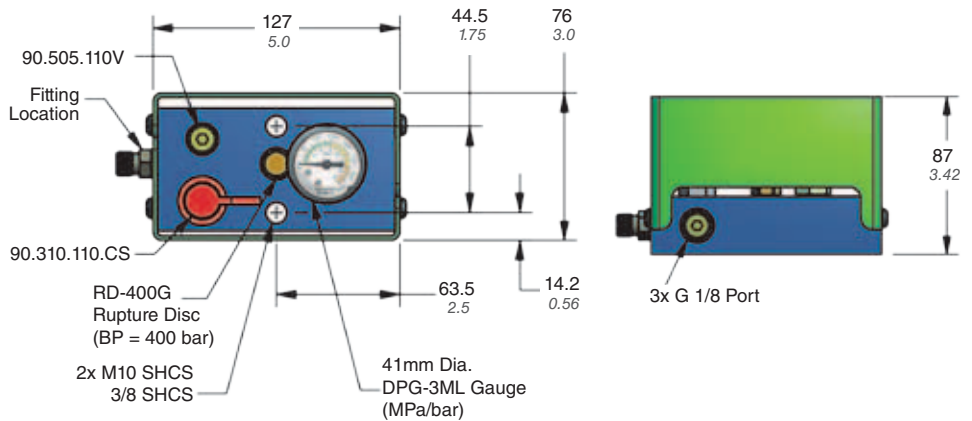

Ordering Example:

90.416. A 2 B

Common Control Panel

Gauge Style
 Bar/MPa Gauge = A
 PSI/Bar Gauge = P

Fitting Connection
 No Fitting = N
 Zip Fitting = B

Guard Options
 None = N
 Top Only = 1
 Top and Bottom = 2

Mini Convertible Control Panel



The DADCO Mini Convertible Control Panel is used to fill, drain and monitor the pressure of linked DADCO nitrogen gas springs from outside the die. The panel is compatible with SMS-[®] and traditional linked systems and has five M6 ports, a high pressure gauge, a quick disconnect fill valve, a bleed valve and a rupture disk to prevent overpressurization. To allow for maximum versatility when linking, the panel is available with a variety of fitting connections.

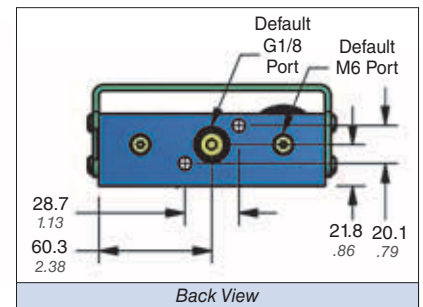
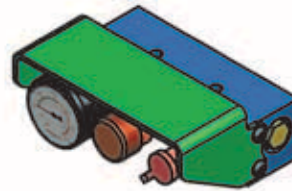

Ordering Example:

90.407. P N

Mini Control Panel

Gauge Style
 PSI/Bar Gauge = P

Fitting Connection
 N = No Fitting Supplied,
 M = Manifold Seal,
 S = ORFS Fitting,
 D = D-24 Fitting,
 B = Zip Fitting,
 L = MINILink[®] Fitting
 When not specified,
 default is N.

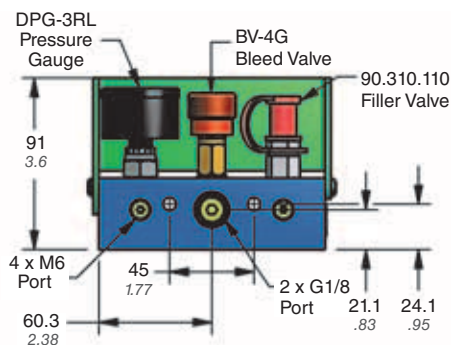
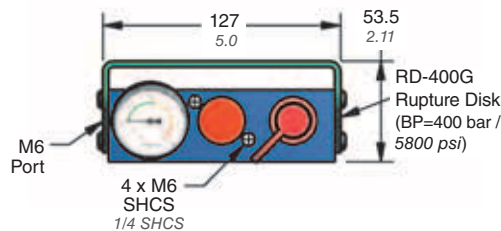

Mounting Options

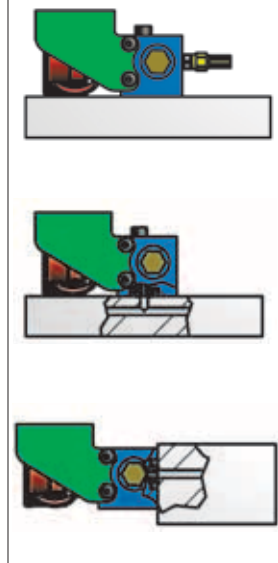

Components: Control Panels

Compact Control Panel

The smallest of our control panels, the DADCO Compact Control Panel is used to fill, drain and monitor the pressure of linked DADCO nitrogen gas springs from outside the die. The panel consists of two G 1/8 BSPP ports, a high pressure gauge, a quick disconnect fill valve, a bleed valve and a rupture disk to prevent overpressurization. To allow for connection to Electronic Pressure Monitors, the panel comes standard with a G 1/4 BSPP port. For Electronic Monitor options, see page 20.

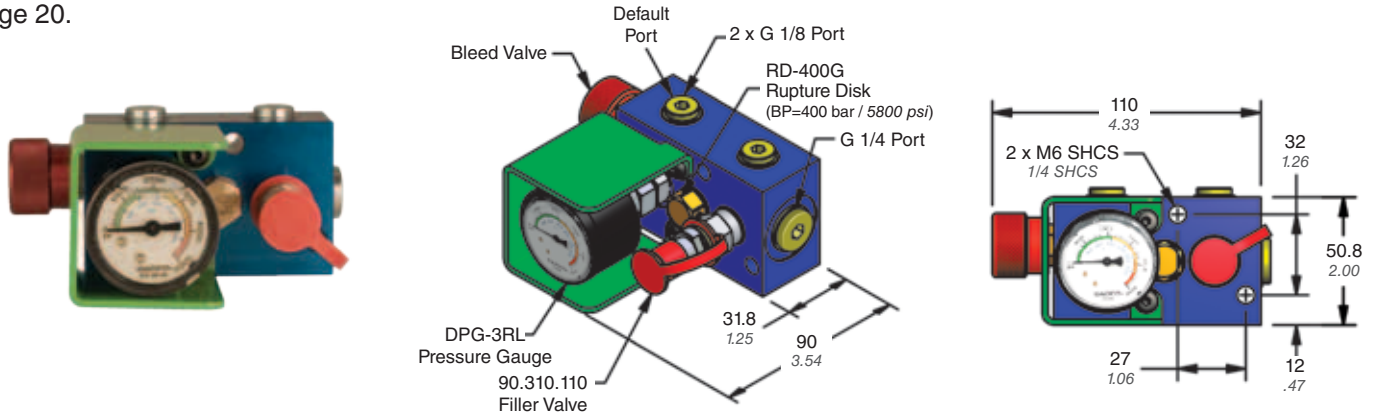

Ordering Example:

Compact Control Panel — 90.405. P N. EDS

Gauge Style
 Bar/MPa Gauge = A
 PSI/Bar Gauge = P

Pressure Monitor Sensor Options (optional)
 EDS = Electronic Pressure Switch, DSK = Piston Pressure Switch, DPS= Dial Pressure Switch, DPT = Electronic Pressure Transmitter

Fitting Connection
 N = No Fitting Supplied,
 S = ORFS Fitting,
 D = D-24 Fitting,
 B = Zip Fitting,
 L = MINILink® Fitting
 When not specified, default is N.

Mini Control Panel

90.407.11G

— For Retrofit Only —

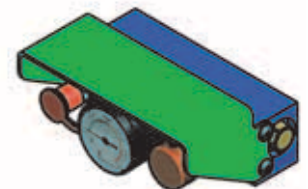
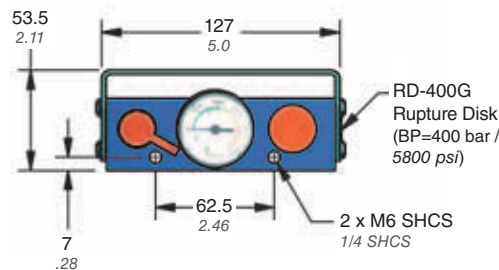

The DADCO 90.407.11G Mini Control Panel is used to fill, drain and monitor the pressure of linked DADCO nitrogen gas springs from outside the die. The panel consists a high pressure gauge, a quick disconnect fill valve, a bleed valve and a rupture disk to prevent overpressurization. To allow for maximum versatility when linking, the panel also contains eleven different port locations.

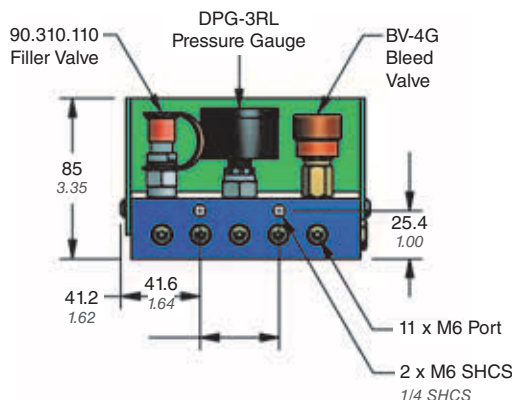

Mounting Options

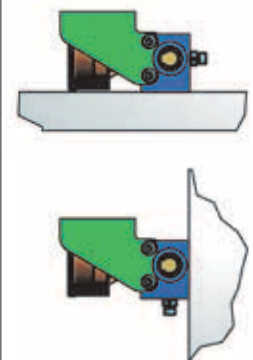

Multi Panel

The DADCO Multi Panel features modules that may be filled, monitored, adjusted and vented from outside the die, either commonly or individually. No other control panel offers the advantages of the DADCO Multi Panel. For replacement parts refer to bulletin B04105B.

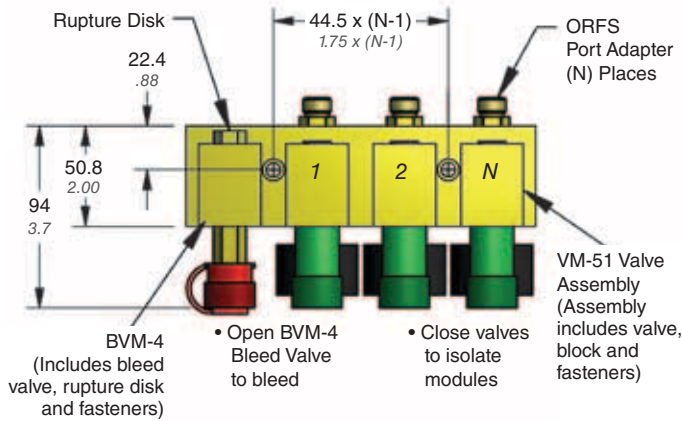

Features

- Each module features a simple two position valve for easy operation.
- Three port locations on each module give maximum piping flexibility.
- Each module is supplied with a straight service fitting.
(For unused ports, DADCO recommends closing the module off before filling or using tube end caps, 90.506.112, on the unused port.)
- The panel can be flush mounted on the bottom or back.
- An optional tilt-guard protects all control valves and gauges during operation.

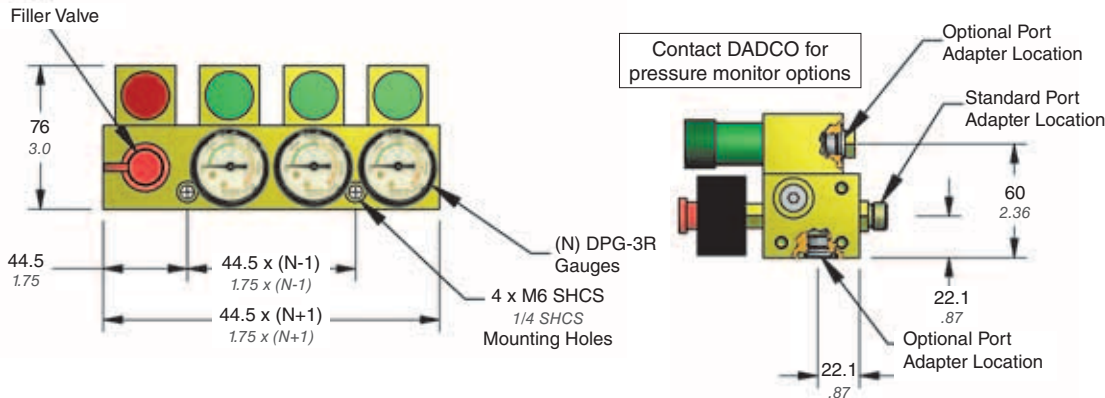

Mounting Options

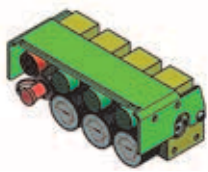
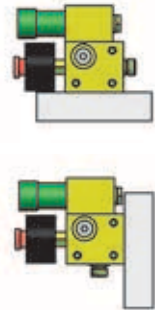

Top Guard – 90.402

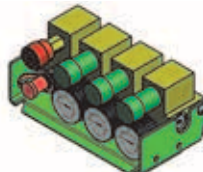
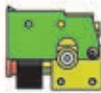

Bottom Guard – 90.403

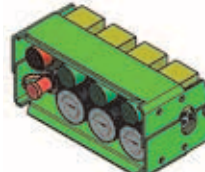
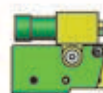

Both Guards – 90.404

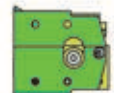

Ordering Example:

90.401. 3.

Guard Location:

Standard (No Guard) = 401, Top = 402,
Bottom = 403, Both = 404

For optional reversed mounting, add R.

Number of Modules:

2-6, 8 or 10

Components: Distribution Blocks

DADCO's distribution blocks are used with a control panel to simplify piping to multiple cylinders with a uniform system pressure. M6 and G 1/8 port options are available.

Mini M6 Distribution Blocks

The Mini Distribution Blocks feature four or eight M6 port locations. Plug unused ports with 90.607.110 Port Plug before charging the system.

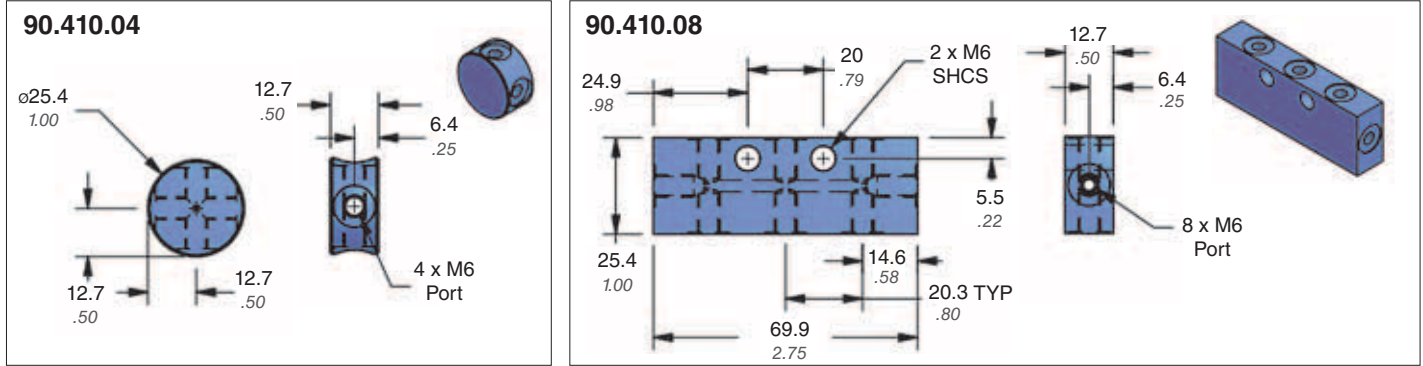

Compact G 1/8 Distribution Blocks

The Compact Distribution Block has 6-12 G 1/8 ports. Plug unused ports with 90.505.110 Port Plug before charging the system.

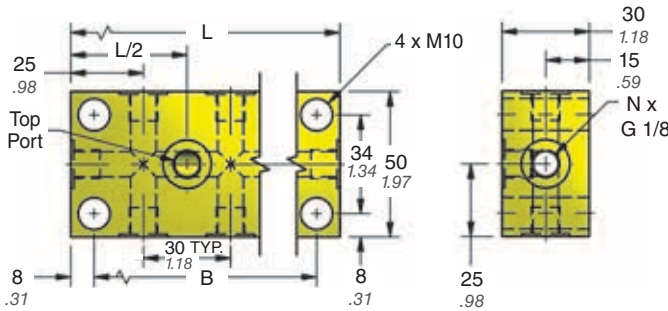

Model	N (Total Ports)	End Ports	Top Port	Side Ports	L	B
90.412.07	7	2	1	4	80 3.15	64 2.52
90.412.09	9	2	1	6	110 4.33	94 3.70
90.412.10	10	2	-	8	140 5.51	124 4.88
90.412.12	12	2	-	10	170 6.69	154 6.06

Standard G 1/8 Distribution Blocks

90.411.04 / 90.411.10 / 90.411.12

The Standard Distribution Block features 4, 10 or 12 G 1/8 ports. Plug unused ports with 90.505.110 Port Plug before charging the system. Refer to bulletin B03142A for more information.

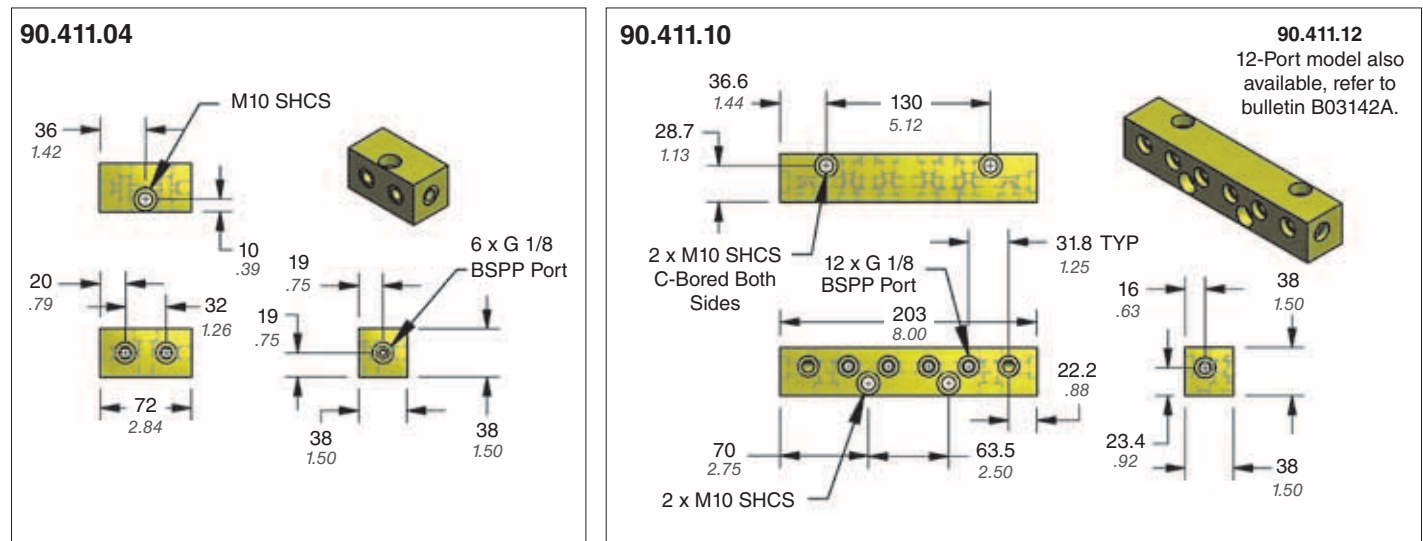

Components: Surge Tanks

DADCO surge tanks are used with open-flow systems to increase the volume in the system thereby reducing the pressure rise when cylinders are stroked. The Surge Tank is offered in two Models: F – Free Flow Model has multiple open ports supplied as standard for maximum flexibility when piping; M1– SMS-i® Model has a bottom port to attach to a base plate. Gauges and shut-off ball valves are available upon request.

For assistance in determining appropriate surge tank size for your system, contact DADCO with the cylinder size, length of stroke being used and amount of pressure rise desired. *DADCO 90.700 (Y-700)/ 90.750 (Y-705) hose is not recommended for use with surge tanks due to restricted flow capability.*



ST.50.150.B29

Preferred Mounts for Surge Tanks. See the 90.10 / 90.8 Series Catalog for mount details.

B11 **90.11**

NOTE: B11 mount available with ST.30-ST.75 models only

B21 **90.21**

B29 **90.29**

Surge Tank	CYL REF	D	E	F	G	H	J	K
30	3000	95 3.74	50 1.97	75 2.95	4 x M10 3/8	25.4 1.00	38 1.50	50.5 1.99
50	5000	120 4.72	90 3.54	120 4.72	4 x M10 3/8	25.4 1.00	38 1.50	78 3.07
75	7500	150 5.91	90 3.54	120 4.72	4 x M10 3/8	25.4 1.00	38 1.50	85 3.35
100	10000	195 7.67	100 3.94	150 5.91	4 x M12 1/2	31.8 1.25	50.8 2.00	98.5 3.88

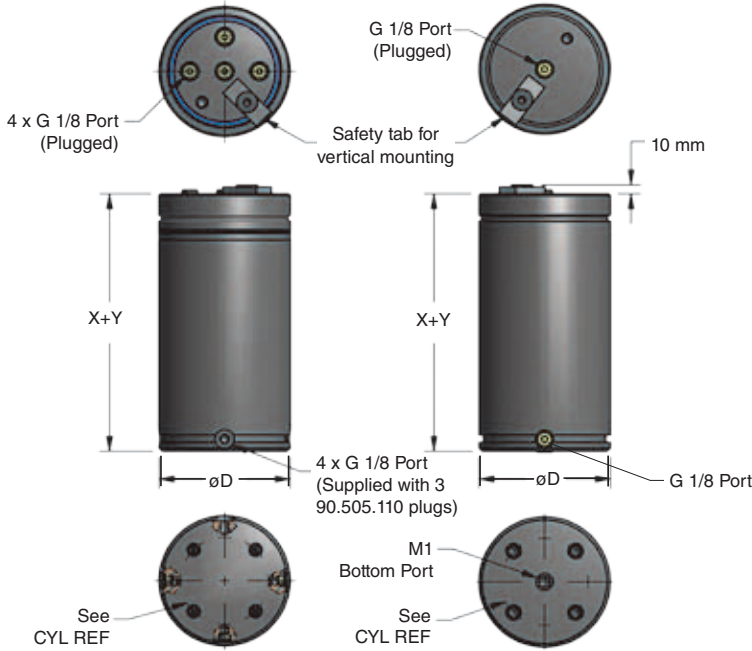

F – Free Flow Model

M1 – SMS-i® Model

ST	30	50	75	100
D	95 3.74	120 4.72	150 5.91	195 7.67
X	117 4.61	137 5.39	152 5.98	157 6.18
Y	Volume of Tank L (in ³)			
50	0.59 1.97	1.05 36	1.71 105	2.92 178
100	0.85 3.94	1.44 52	2.33 142	3.99 244
150	1.10 5.91	1.83 67	2.94 180	5.06 309
200	1.35 7.87	2.22 82	3.56 217	6.13 374
250	1.60 9.84	2.62 98	4.17 254	7.20 439
300	1.85 11.81	3.01 113	4.78 292	8.27 505
350	2.10 13.78	3.40 128	5.40 329	9.34 570
400	2.35 15.74	3.79 144	6.01 367	10.41 635

SMS-i® Surge Tank Connection

DADCO surge tanks ordered with the M1 operating system are used in a SMS-i® and have a bottom port. These tanks are attached to the base plate with a sealing washer and standard mounting hardware.

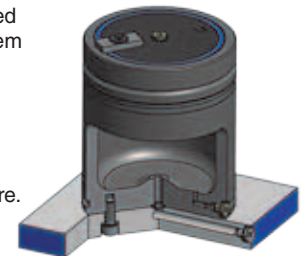

Ordering Example: **ST.30. 150. TO. F**

Size: 30, 50, 75, 100

Length (Y): 50, 100, 150, 200, 250, 300, 400

Charging Medium: Nitrogen Gas

Operating Temperature: 4°C – 71°C (40°F – 160°F)*



Operating System: F = Free Flow Fitting, M1 = SMS-i® (Bottom port + sealing component)

Mount Option: TO = Basic Model. *When not specified, default is TO.* Mount ordered with cylinder will be attached at factory.

Charging Pressure Range: 15 – 150 bar (220 – 2175 psi)

**Note: Surge Tank pressure should not exceed 264 bar (3828 psi) at maximum temperature.*

Components: Hose

<p>MINIFLEX® <i>Preferred</i> 90.700 (Y-700) Hose</p> <ul style="list-style-type: none"> + Offers the smallest possible bend radius available for flexible hose + Compatible with Mini, ORFS, D-24 and Zip style fittings - Cannot be linked with a surge tank 	<p>MINIFLEX® 90.705 (Y-705) Hose</p> <ul style="list-style-type: none"> + Compatible with Mini, ORFS, D-24 and Zip style fittings + High burst pressure - Cannot be linked with a surge tank - Large bend radius 	<p>DADCOFLEX® <i>Preferred</i> 90.500 (Y-500) Hose</p> <ul style="list-style-type: none"> + Higher working pressure than 90.250 (Y-250) without sacrificing bend radius or flow rate + Compatible with ORFS and D-24 style fittings + Can be linked with a surge tank 
<p>DADCOFLEX® 90.400 (Y-400) Hose</p> <ul style="list-style-type: none"> + Can withstand high pressures while maintaining a good flow rate + Can be linked with a surge tank - Least flexible bend radius 	<p>DADCOFLEX® 90.250 (Y-250) Hose</p> <ul style="list-style-type: none"> + Assemble in field without additional tools using non-crimped adapters - 190 bar (2750 psi) is maximum for surging pressure 	<p>DF Tubing DF. _____ <i>Length (mm)</i></p> <ul style="list-style-type: none"> + Extremely durable and compact - Dimensions critical, no flexibility <p><i>NOTE: To order straight lengths of DF Tubing, use the part number above. For curved pieces, it is necessary to provide a drawing. Refer to Bulletin B02118B for more information.</i></p> 

Preferred

Preferred

Part No.	OD	ID	Working Pressure	Burst Pressure	Bend Radius	Crimp Die
90.700 (Y-700)	5	2	500 bar 7250 psi	1890 bar 27405 psi	15 .59	Mini-Crimp 90.710.8 No Ring Required
90.705 (Y-705)	5	2	500 bar 7250 psi	1940 bar 28130 psi	20 .79	
90.500 (Y-500)	11	5	345 bar 5000 psi	1380 bar 20000 psi	38 1.50	80C-P03 Gray Die 82C-R01 Ring
90.400 (Y-400)	13	6.5	345 bar 5000 psi	1380 bar 20000 psi	50 1.97	
90.250 (Y-250)	12	6.4	190 bar 2750 psi	758 bar 11000 psi	38 1.50	80C-P04J Red Die 82C-R01 Ring
DF Tubing	6.4	4.5	260 bar 3750 psi	1000 bar 15000 psi	15.9 .625	

DADCO offers hydraulically or pneumatically operated crimping units, turn to page 22 for more information.

Hose Assembly

A DADCO hose assembly consists of a length of hose with a hose adapter on each end. Refer to bulletin 99B105E for more information on ordering a hose assembly.

Hose Assembly
Ordering Example: **90.500. S843. S854. 600. I**

Hose Type _____
 (700, 705, 500, 400 or 250)

Hose Adapters _____

Sealing Type	Example
ORFS	S943
D-24	D843
Mini	L943
Zip	B943

Orientation
 Hose adapter orientation:
 I, C or S

Length of Hose Assembly (L) in mm
 Distance between sealing faces

Reference appropriate sealing type prefix (S, D, L or B).

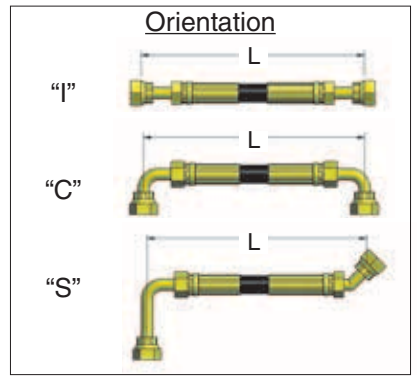

Hose Straps

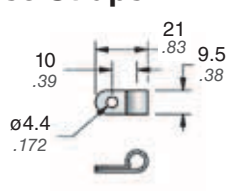
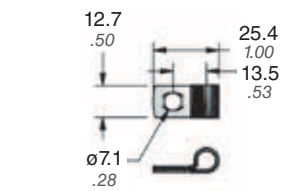
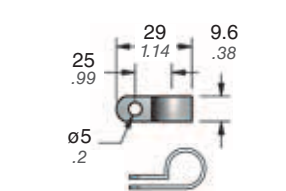
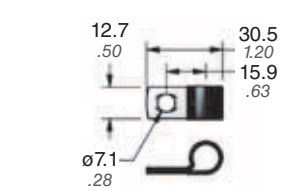
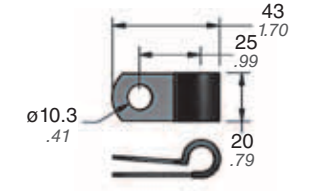
 <p>90.504.701 (HS-701) for use with 90.700 and 90.705 hose types</p>	 <p>90.504.700 (HS-700) for use with 90.700 and 90.705 hose types</p>	 <p>90.504.250 (HS-250) for use with 90.500, 90.400 and 90.250 hose types</p>	 <p>90.504.500 (HS-500) for use with 90.500 and 90.250 hose types</p>	 <p>90.504.400 (HS-400) for use with 90.500, 90.400 and 90.250 hose types</p>
--	--	--	---	--

Components: ORFS Hose Adapters

DADCO was the first gas spring manufacturer to offer 9/16-18 O-Ring Face Seals (ORFS). DADCO's ORFS fittings prevent any loss of high pressure nitrogen gas by providing elastomeric seals at every joint. DADCO recommends using DADCO brand hoses featured on page 11 with the adapters shown throughout this catalog. If the length of hose required is less than the H Value, use DF Tubing (page 11) or Solid Hose Fittings (page 13). DADCO also offers a variety of stainless steel fittings to be paired with Y-705 or Y-500 hose for linked operation in extreme condition environments.

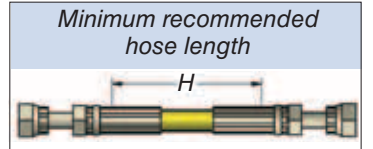

.SS = Stainless Steel Option Available

Crimped Hose Adapters for 90.700 or 90.705 (Y-700 or Y-705)

H Value = 75 (2.95)

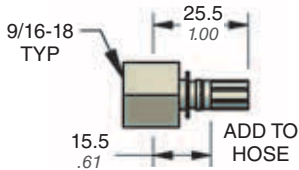

90.504.943 **.SS**
(S-943)
Straight Swivel

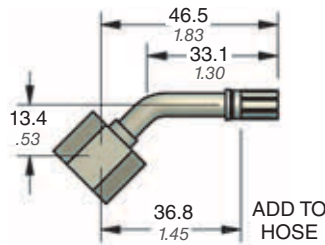

90.504.954
(S-954)
45° Swivel

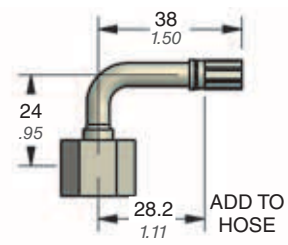

90.504.959
(S-959)
90° Swivel

Crimped Hose Adapters for 90.500 (Y-500)

H Value = 80 (3.15)

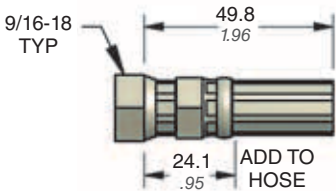

90.504.843 **.SS**
(S-843)
Compact Swivel

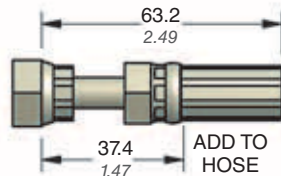

90.504.851
(S-851)
Retractable Swivel

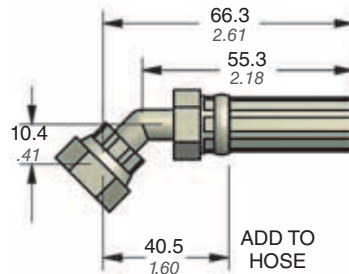

90.504.854
(S-854)
45° Female Face Seal

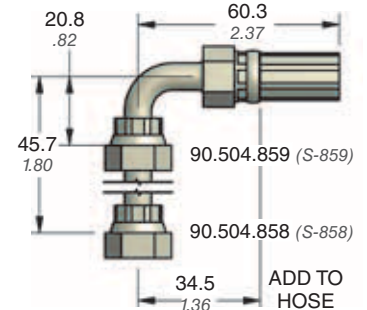

90.504.859 (S-859) Short Neck
90.504.858 (S-858) Long Neck

Crimped Hose Adapters for 90.250 or 90.400 (Y-250 or Y-400)

H Value = 85 (3.35)

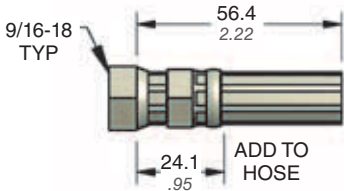

90.504.743
(S-743)
Compact Swivel

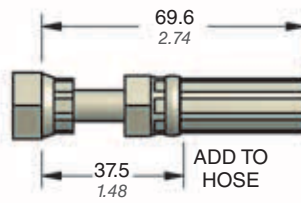

90.504.751
(S-751)
Retractable Swivel

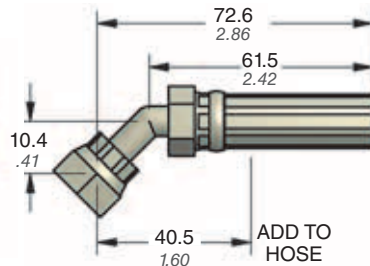

90.504.754
(S-754)
45° Female Face Seal

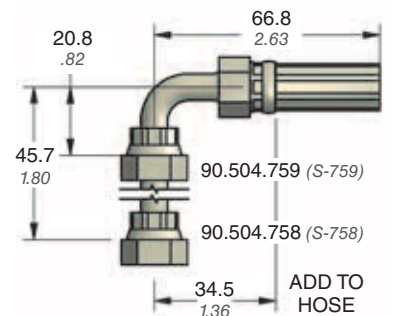

90.504.759 (S-759) Short Neck
90.504.758 (S-758) Long Neck

Non-Crimped Hose Adapters for 90.250 (Y-250)

H Value = 85 (3.35)

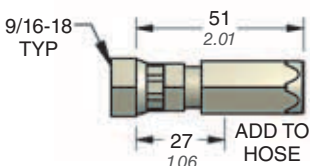

90.504.643
(S-643)
Compact Swivel

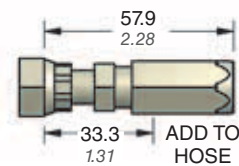

90.504.651
(S-651)
Retractable Swivel

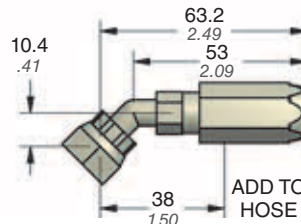

90.504.654
(S-654)
45° Female Face Seal

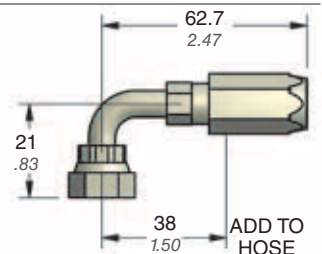

90.504.659
(S-659)
90° Female Face Seal

Components: ORFS Fittings

Solid Hose Fittings

Solid hose fittings come in predetermined lengths and are ideal for limited space applications. They can replace traditional hose assemblies, particularly when the length of hose required is shorter than DADCO's recommended minimum hose length (see H Values on page 12). For custom lengths of solid hose, see DF Tubing on page 11.

Metric

Part No.	A	B
90.503.xxxx (S-9xxx)	mm	A - 43.2
9075	75	31.8
9100	100	56.8
9120	120	76.8
9125	125	81.8
9130	130	86.8
9140	140	96.8
9150	150	106.8

English

Part No.	A	B
90.503.xxx (S-8xx)	in.	A - 1.70
830	3.00	1.30
832	3.25	1.55
835	3.50	1.80
837	3.75	2.05
840	4.00	2.30
845	4.50	2.80
850	5.00	3.30
855	5.50	3.80
860	6.00	4.30

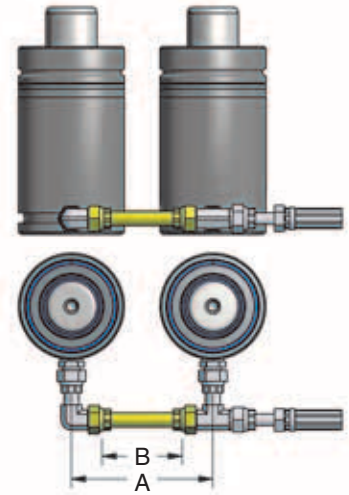

Port Adapters

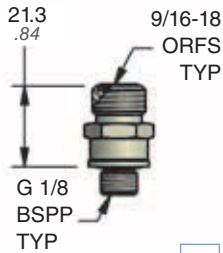

90.505.115 .SS
(S-115)
Straight

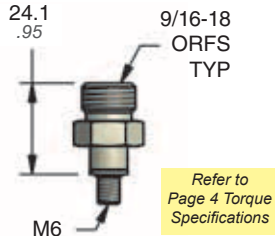

90.505.116
(S-116)
M6 → 9/16-18

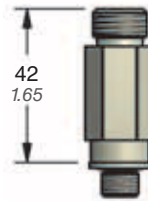

90.505.117
(S-117)
Extended Straight

DADCO's O-Ring Face Seal (ORFS) Fittings have elastomeric seals at every joint.



.SS = Stainless Steel Option Available

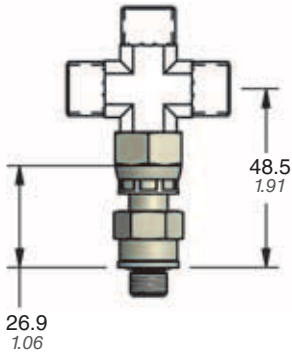

90.505.121
(S-121)
Swivel Straight

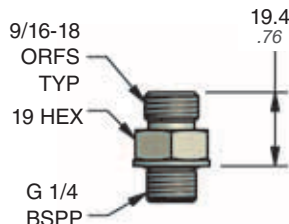

90.505.122
(S-122)
Straight

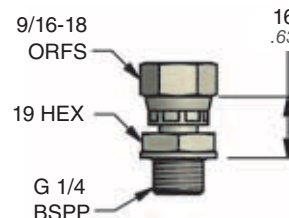

90.505.123
(S-123)
Swivel Straight

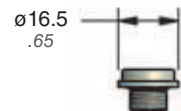

90.505.110
(G-109)
Flush Plug

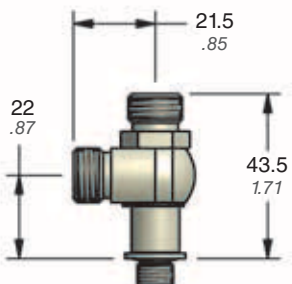

90.505.438
(S-438)
Run Tee

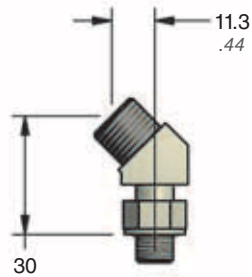

90.505.330
(S-330)
45° Elbow

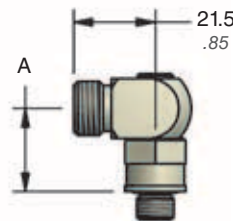

90.506.230
(S-230)
90°

Part No.	A
230 .SS	22 .87
240	36 1.42
250	43 1.69

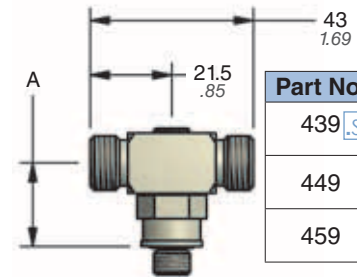

90.506.439
(S-439)
Branch Tee

Part No.	A
439 .SS	22 .87
449	36 1.42
459	43 1.69

Fittings

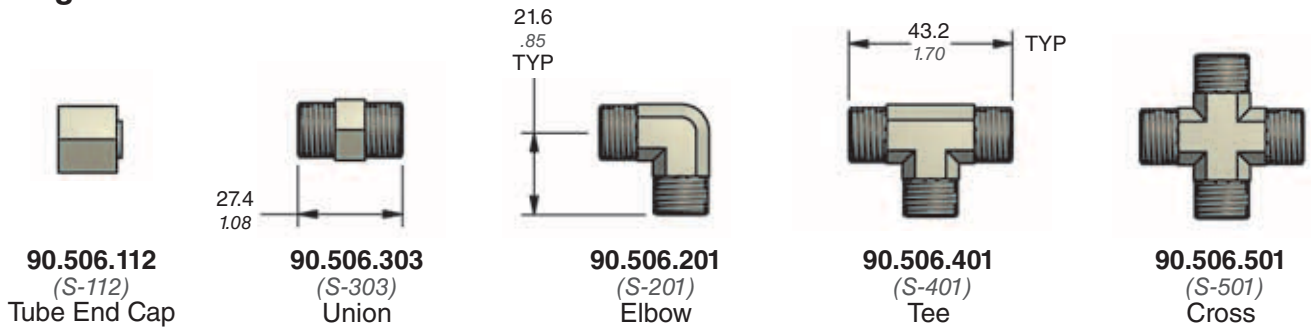

Standard Swivel Nut Fittings

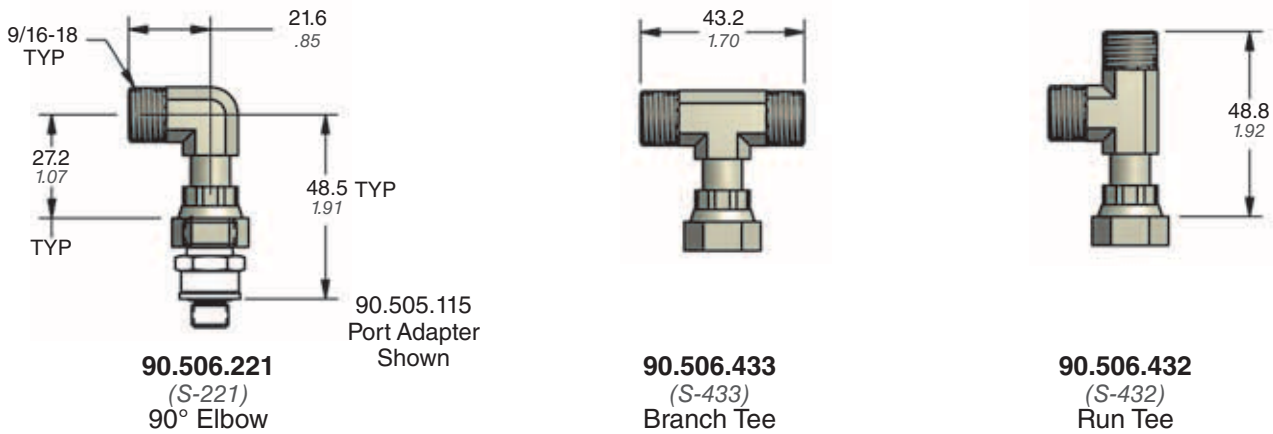

Compact Swivel Nut Fittings

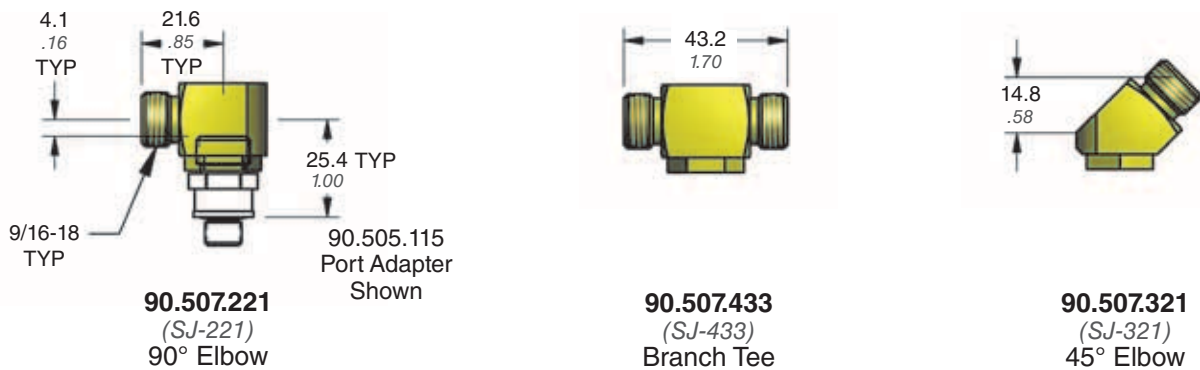

Retrofit Port Adapters

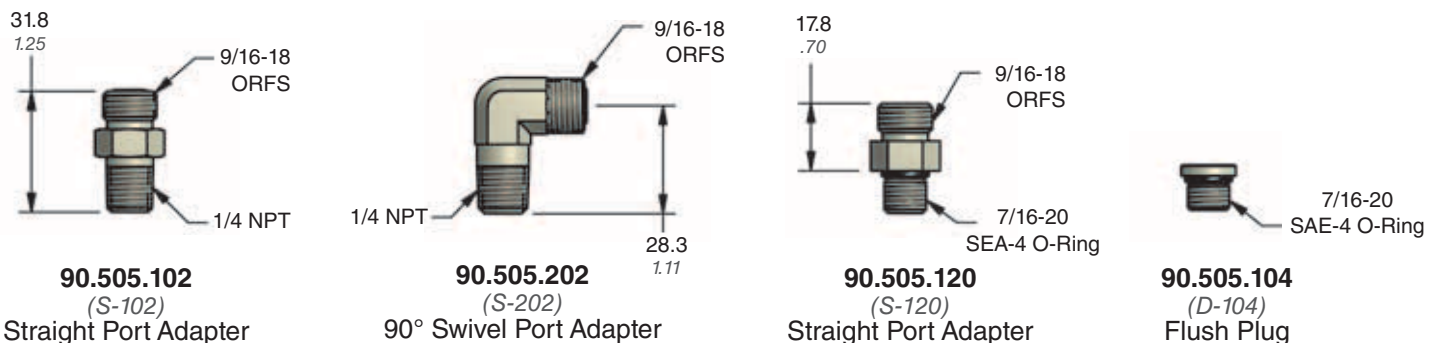

Components: D-24 Tapered Fittings

D-24 Hose System with 90.700 or 90.705 (Y-700 or Y-705)

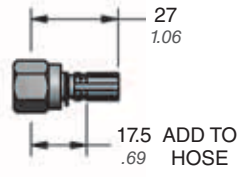
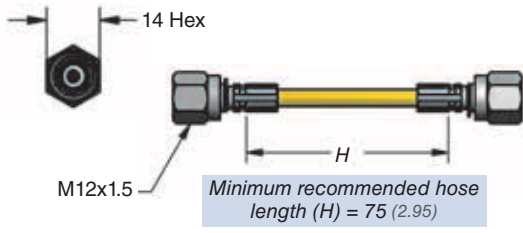

90.508.943 (D-943)
Compact Hose Adapter

DADCO's D-24 Fittings have a 24° taper and o-ring.

DIN EN ISO 8434
24° Taper + O-Ring

D-24 Hose System with 90.500 (Y-500)

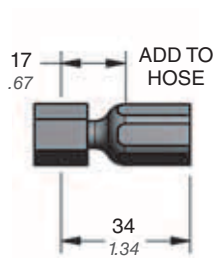
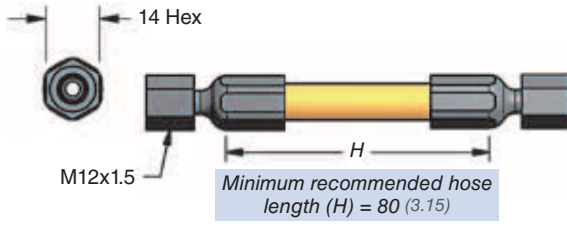

90.508.843 (D-843)
Compact Hose Adapter

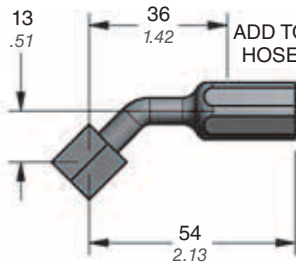

90.508.854 (D-854)
45° Hose Adapter

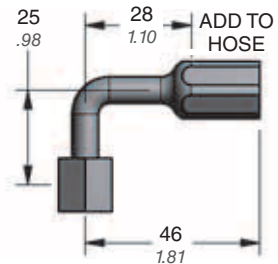

90.508.858 (D-858)
90° Hose Adapter

Fittings

<p>90.508.115 (D-115) Straight Port Adapter</p>	<p>90.508.116 (D-116) Straight Port Adapter</p>	<p>90.508.120 (D-120) Straight Port Adapter</p>	<p>90.508.607 (D-607) Reducing Union</p>	<p>90.508.112 (D-112) Tube End Cap</p>	<p>90.508.439 (D-439) Branch Tee</p>	<table border="1"> <thead> <tr> <th>Part No.</th> <th>A</th> </tr> </thead> <tbody> <tr> <td>439</td> <td>22 .87</td> </tr> <tr> <td>449</td> <td>36 1.42</td> </tr> <tr> <td>459</td> <td>43 1.69</td> </tr> </tbody> </table>	Part No.	A	439	22 .87	449	36 1.42	459	43 1.69								
Part No.	A																					
439	22 .87																					
449	36 1.42																					
459	43 1.69																					
<p>90.508.221 (D-221) 90° Elbow</p>	<p>90.508.432 (D-432) Run Tee</p>	<p>90.508.433 (D-433) Branch Tee</p>	<p>90.508.321 (D-321) 45° Elbow</p>	<p>90.508.201 (D-201) Elbow</p>	<p>90.508.230 (D-230) 90° Branch Tee</p>	<table border="1"> <thead> <tr> <th>Part No.</th> <th>A</th> </tr> </thead> <tbody> <tr> <td>230</td> <td>22 .87</td> </tr> <tr> <td>240</td> <td>36 1.42</td> </tr> <tr> <td>250</td> <td>43 1.69</td> </tr> </tbody> </table>	Part No.	A	230	22 .87	240	36 1.42	250	43 1.69								
Part No.	A																					
230	22 .87																					
240	36 1.42																					
250	43 1.69																					
<p>90.508.303 (D-303) Union</p>	<p>90.508.401 (D-401) Tee</p>	<p>90.508.501 (D-501) Cross</p>	<p>90.508.438 (D-438) Run Tee</p>	<p>90.508.539 (D-539) Cross Tee</p>	<table border="1"> <thead> <tr> <th>Part No.</th> <th>A</th> </tr> </thead> <tbody> <tr> <td>438</td> <td>22 .87</td> </tr> <tr> <td>448</td> <td>36 1.42</td> </tr> <tr> <td>458</td> <td>43 1.69</td> </tr> </tbody> </table>	Part No.	A	438	22 .87	448	36 1.42	458	43 1.69	<table border="1"> <thead> <tr> <th>Part No.</th> <th>A</th> </tr> </thead> <tbody> <tr> <td>539</td> <td>22 .87</td> </tr> <tr> <td>549</td> <td>36 1.42</td> </tr> <tr> <td>559</td> <td>43 1.69</td> </tr> </tbody> </table>	Part No.	A	539	22 .87	549	36 1.42	559	43 1.69
Part No.	A																					
438	22 .87																					
448	36 1.42																					
458	43 1.69																					
Part No.	A																					
539	22 .87																					
549	36 1.42																					
559	43 1.69																					

Refer to Page 4 Torque Specifications

MINIFLEX® Hose System with 90.700 or 90.705 (Y-700 or Y-705) Hose

.SS = Stainless Steel Option Available

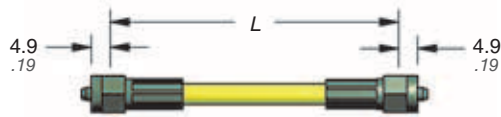

Minimum recommended distance between sealing faces (L) = 75 (2.95)

90.700.L943.L943.____.I
L (mm)
Hose Assembly

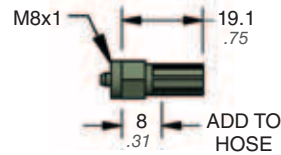

90.601.943 **.SS**
(L-943)
Permanent Hose Adapter

MINILink® Fittings

Micro Series (C.045 – C.250) and small **Ultra Force**® Series (U.0175/U.0325) Port Adapters

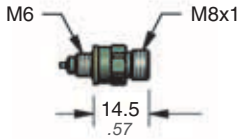

90.607.122
(L-122)
Micro Service Fitting

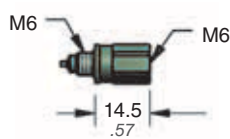

90.607.038
(L-38)
Micro Port Adapter Extension

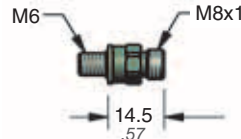

90.607.120 **.SS**
(L-120)
Straight Port Adapter

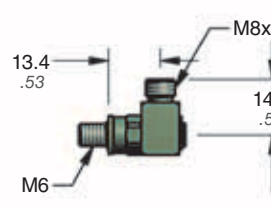

90.607.220 **.SS**
(L-220)
90° Port Adapter

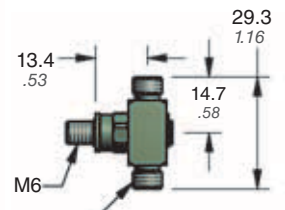

90.607.429 **.SS**
(L-429)
Branch Tee Port Adapter

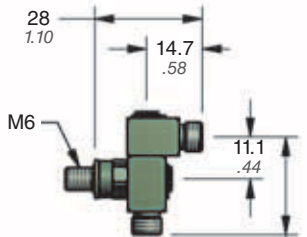

90.607.428
(L-428)
Run Tee Port Adapter

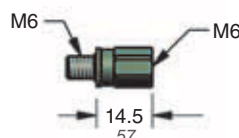

90.607.035
(L-35)
Port Adapter Extension

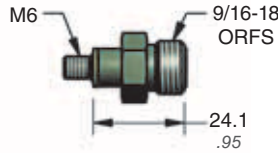

Refer to Page 4 Torque Specifications

90.505.116
(S-116)
Reducer
M6 → 9/16-18

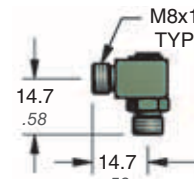

90.607.201
(L-201)
Elbow

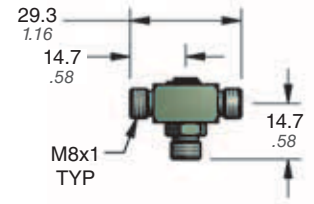

90.607.401
(L-401)
Union Tee

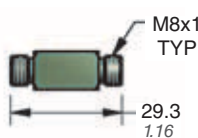

90.606.303
(L-303)
Union

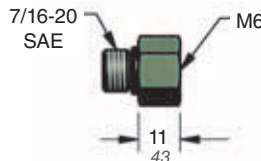

90.607.055
(L-55)
Reducer
7/16-20 → M6

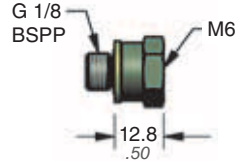

90.607.065
(L-65)
Reducer
G 1/8 → M6



90.607.115
(L-115)
Reducer
G 1/8 → M8x1

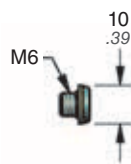

90.607.110
(L-110)
Port Plug



90.605.109
(L-109)
Fitting Plug

M6 → G 1/8 Port Adapters

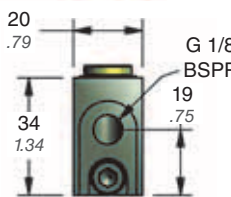
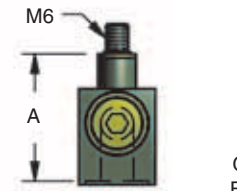

90.607.116
Straight

Part No.	A
116	33 1.30
126	46 1.81

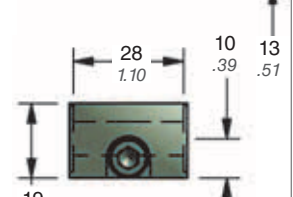
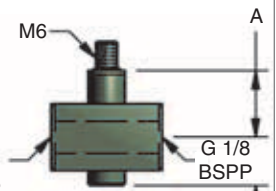

90.607.439
Branch Tee

Part No.	A
439	18 .71
449	31 1.22

Components: Zip (CNOMO) Fittings

Zip Hose System with 90.700 or 90.705 (Y-700 or Y-705)

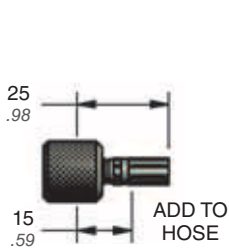
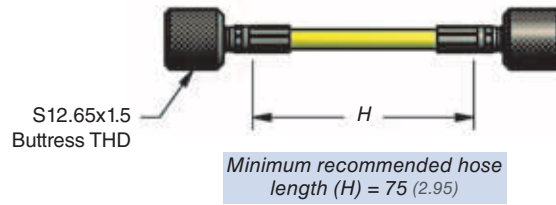

90.804.943
(B-943)
Straight Hose Adapter

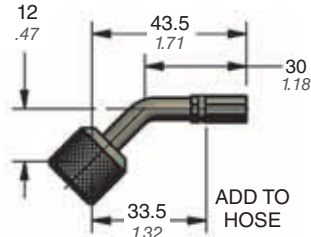

90.804.954
(B-954)
45° Hose Adapter

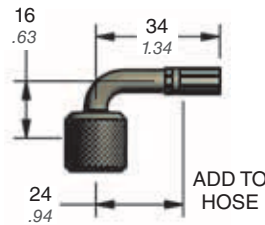

90.804.958
(B-958)
90° Short Neck
Hose Adapter

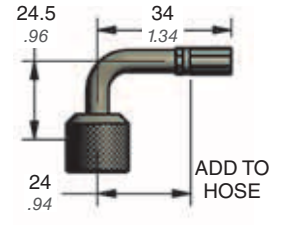

90.804.959
(B-959)
90° Long Neck
Hose Adapter

Fittings

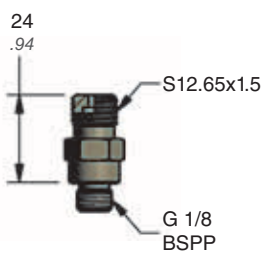

90.805.115
(B-115)
Straight Port Adapter

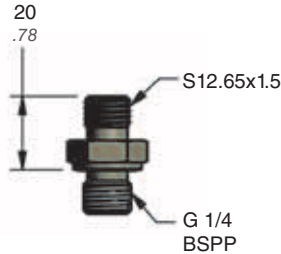

90.805.122
(B-122)
Straight Port Adapter

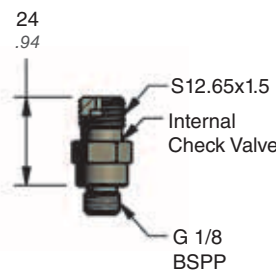

90.805.190
(B-190)
Port Adapter with Valve

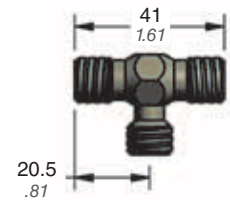

90.806.401
(B-401)
Tee

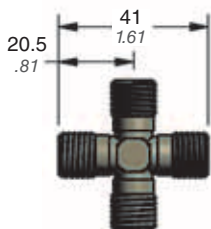

90.806.501
(B-501)
Cross

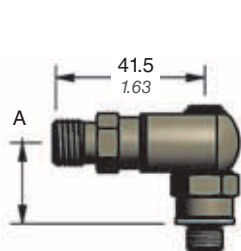

90.806.230
(B-230)
Angle Swivel Adapter

Part No.	A
230	22 .87
240	36 1.42
250	43 1.69

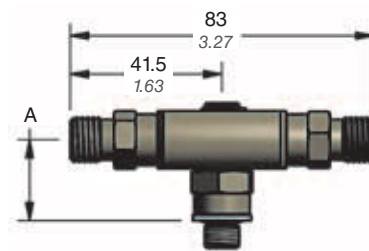

90.806.439
(B-439)
Two-Way Swivel Adapter

Part No.	A
439	22 .87
449	36 1.42
459	43 1.69

Pressure Monitors

DADCO offers a variety of pressure monitor options to alert press controllers to changes in system pressure. The 90.421.1 and 90.421.2 models visually alert the user whether the pressure is at good standing or low while the 90.421.2D model is capable of shutting the press down if it drops below the minimum operating pressure.

Model No.	Supply Voltage	Switch Rating	Output	Electrical Connection	Pressure Range	Bulletin No.
90.421.1 (DPM-1)	120 VAC	-	Indicator Light	1/2 NPS	15 – 200 bar 220 – 3000 psi	B00136
90.421.2 (DPM-2)	24 VDC	-	Indicator Light	1/2 NPS	15 – 200 bar 220 – 3000 psi	B01115A
90.421.2D (DPM-2D)	24 VDC	0.4 A	Indicator Light + SPDT	4-Pin Mini-Change Connector	15 – 200 bar 220 – 3000 psi	B00134

90.421.1 (DPM-1) 90.421.2 (DPM-2)

Dimensions:
 Total width: 149.9 (5.90)
 Width to center: 125.0 (4.92)
 Width to left side: 104.1 (4.10)
 Total height: 101.6 (4.00)
 Height to top of indicator: 75.0 (2.95)
 Mounting hole offset: 81.3 (3.20)

Wiring Diagrams:
DPM-1 Circuit: 120 VAC (Neutral/White, Hot/Black) connected to N.C. (Green) and N.O. (Red) terminals. COM is common.
DPM-2 Circuit: 24 VDC (+, -) connected to N.C. (Red) and N.O. (Green) terminals. COM is common.
 Legend: -----: Pressure < Set Point; ———: Pressure > Set Point

The DPM-1 and DPM-2 models both visually inform the press operator of their Nitrogen Gas Spring system's pressure status. See table for supply voltage.

90.421.2D (DPM-2D)

Dimensions:
 Total width: 149.9 (5.90)
 Width to center: 125.0 (4.92)
 Width to left side: 104.1 (4.10)
 Total height: 101.6 (4.00)
 Height to top of indicator: 75.0 (2.95)
 Mounting hole offset: 81.3 (3.20)

Wiring Diagrams:
DPM-2D Circuit: 24 VDC (+, -) connected to N.C. (Red) and N.O. (Green) terminals. COM is common. Includes a SPDT switch for automatic shut-down.
Plug Pin-Out: (1) Black (-24 VDC), (2) White, (3) Red, (4) Green (+24 VDC).
 Legend: -----: Pressure < Set Point; ———: Pressure > Set Point

The DPM-2D model visually informs the press operator of the system status, and can be wired into the press controller to automatically shut down or alert the operator when pressure drops below a set point.

Ordering Example:

90.421.2D. *BH1. BP. 102

<p>Model Number 90.421.1, 90.421.2 or 90.421.2D</p> <p>Connector BH1 – Right BH2 – Left BH3 – Straight Connector <i>(*Connector options are for 90.421.2D Model only.)</i></p>	<p>Fitting 90.505.102–Straight 90.505.202–90°</p> <p>Backing Plate (optional)</p>
--	---

Components: Pressure Monitors

Electronic Pressure Monitors



DADCO offers two types of Electronic Pressure Monitors to monitor nitrogen gas pressure during operation: An Electronic Pressure Monitor Sensor or a Control Panel with Pressure Monitor. For maximum versatility both types have multiple configurations to best suit your application. Pressure Monitor sensor options are detailed on page 20.

Electronic Pressure Monitor Configuration

To customize your Electronic Pressure Monitor, select the base, sensor and cable accessory that best suits your application.

Example shown:
90.421.CP.S.EDS.G
 With 90.454.M12.S Cable





Cable Accessory

 90.454.M12.S.____	 90.454.M12.L.____
Attachment Orientation: S = Straight Attachment Orientation: L = Elbow	
Cable Length: 02 = 2 m, 05 = 5 m, 10 = 10 m	
Applicable for EDS, DPS & DPT sensor options	

Guard Option



 G

Pressure Monitor Sensor Options

 EDS	 DSK	 DPS	 DPT
--	---	---	---

See page 20 for details.

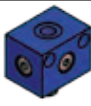
Base Options

 JB	 CP
--	--

GM specific option available, reference bulletin B16106.

Ordering Example:

90.421. CP. S. EDS. G

Model Number

Base Option

JB = Block only (Bleed Valve, Filler Valve and Rupture Disk not included),
 CP = Block with Bleed Valve, Filler Valve and Rupture Disk

Guard Option

Pressure Monitor Sensor Options

EDS = Electronic Pressure Switch, DSK = Piston Pressure Switch, DPS = Dial Pressure Switch, DPT = Electronic Pressure Transmitter

Fitting Connection

N = No Fitting Supplied, S = 90.505.115 (ORFS),
 D = 90.508.115 (D-24), B = 90.805.115 (Zip),
 L = MINILink® Fitting. Default is N.

Components: Pressure Monitors

Electronic Pressure Monitor Sensors

The Electric Pressure Monitor has four sensor options available: EDS, DSK, DPS and DPT. Review the details provided below to select the correct option for your application.

EDS – Electronic Pressure Switch

The EDS switch features an LED digital display that reads pressure value in bar, psi or MPa. The EDS models display face rotates 270° while the body rotates 340° for added versatility, the sensor also features two switching outputs that can be easily set with face mounted push buttons. *Note: EDS uses 90.454.M12 style cable accessory.*

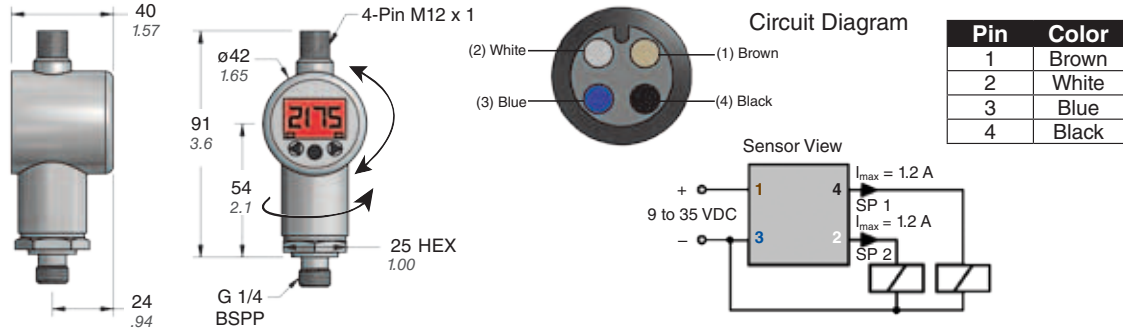

- | | | | | |
|------------------|--------------------|------------------------|--------------------------|------------------|
| Features: | • Measuring Range: | 0-400 bar (0-5800 psi) | • Output: | (2) PNP Pin 2, 4 |
| | • Supply Voltage: | 9 – 35 VDC | • Electrical Connection: | 4 – pole M12 x 1 |
| | • Switch Rating: | 1.2 A max | • Current Consumption: | 35 mA max |

DSK – Piston Pressure Switch

The DSK switch uses a pressure input to operate a SPDT switch as the pressure rises or falls across a set value. The manually adjusted switch monitors a preset pressure. This switch can be set at the factory and wired to shut down a press operation or activate an alarm once pressure is above or below the set-point. *Note: DSK includes a DIN 43650 cable adapter.*

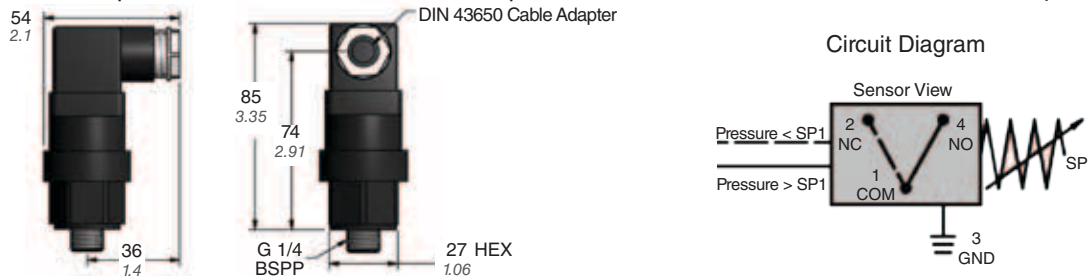

- | | | | | |
|------------------|--------------------------|--------------------|----------------------------|-----------------------------------|
| Features: | • Max Pressure Rating: | 600 bar (8700 psi) | • Range Tolerance: | ± 5 bar (± 72.5 psi) |
| | • Output: | SPDT Switch | • Switch Adjustment Range: | 50-200 bar (725-2900 psi) |
| | • Electrical Connection: | DIN 43650 | • Switch Rating: | 1 AMP at 250 VAC, 4 AMP at 24 VDC |

DPS – Dial Pressure Switch

The DPS switch features two manually adjustable dials. The upper dial is the set pressure and the lower dial is the reset pressure. When the system pressure increases to the set value, Output 1 (pin 4) turns on, and Output 2 (pin 2) turns off. When the system pressure decreases to the Reset Pressure, Output 1 turns off and Output 2 turns on. *Note: DPS uses 90.454.M12 style cable accessory.*

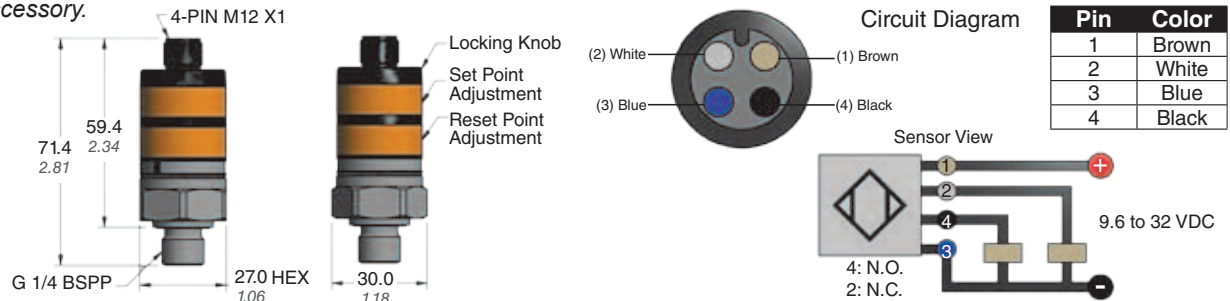

- | | | | | |
|------------------|------------------------|---------------------------|--------------------------|-------------------------------------|
| Features: | • Measuring Range: | 0-400 bar (0-5800 bar) | • Electrical Connection: | 4 - Pole M12 x 1 |
| | • Operating Voltage: | 9.6 - 32 VDC | • Current Consumption: | <25 mA |
| | • Setting Point Range: | 20-400 bar (290-5800 psi) | • Switch Output: | PnP (1 N.O. & 1 N.C. Complementary) |
| | • Reset Point Range: | 12-392 bar (175-5685 psi) | • Switch Point Accuracy: | < ± 2.5% |
| | • Switch Rating: | 500 mA | | |

Components: Pressure Monitors

DPT – Electronic Pressure Transducer

DADCO's DPT unit is a pressure transducer, emitting an analogue signal that provides a range of voltage. The DPT converts pressure input to a 0 – 10 V output, the voltage output can then be scaled by a press controller to read the pressure value.

Note: DPT uses 90.454.M12B style cable accessory.

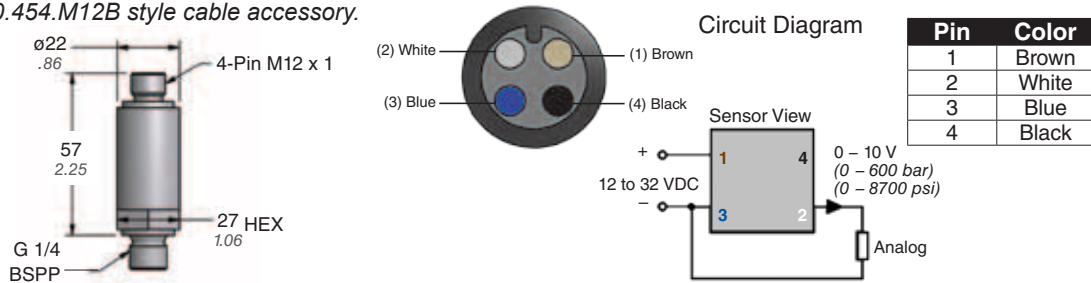

Features:	Supply Voltage:	Accuracy:	Output Signal:	Max Pressure Rating:	Electrical Connection:	Current Consumption:
	12 – 32 VDC	0.5% Full Scale	Analog (0-10 Volts)	600 bar (8700 psi)	4 – Pin M12 x 1	<15 mA

90.406.421 Control Panel with Pressure Monitor



The 90.406.421. Control Panel with Pressure Monitor is used to fill and monitor the pressure of linked nitrogen gas springs from outside the die. The panel is adjustable to read pressure in bar, psi or MPa and includes a digital pressure sensor with programmable output to signal if pressure drops below a preset level. This panel conforms to Toyota standard number D-PACPS-B.

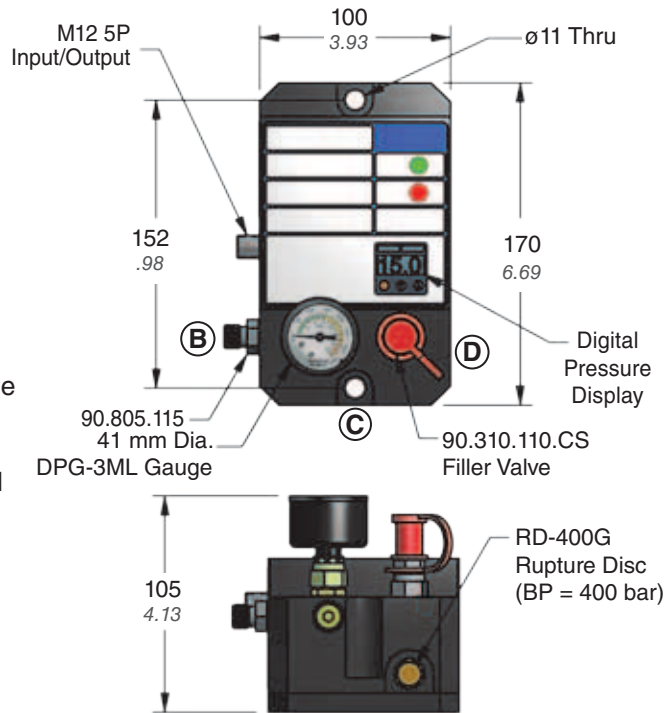

DADCO 90.406.421 Digital Control Panel		 Process Control Equipment E476453 Assembled in the USA with foreign and domestic parts																					
M12B Cordset Only 90.454.M12B																							
	<table border="1"> <tr> <td>Voltage</td> <td>12 - 24 DC</td> <td>100 - 120 AC</td> </tr> <tr> <td>Current</td> <td>80 - 40 mA</td> <td>60 mA</td> </tr> <tr> <td>1 BRN</td> <td>⊕</td> <td>L1</td> </tr> <tr> <td>3 BLU</td> <td>⊖</td> <td>L2</td> </tr> <tr> <td>2 WHT</td> <td>12 - 24 DC</td> <td>100 - 120 AC</td> </tr> <tr> <td>4 BLK</td> <td>2A</td> <td>1A</td> </tr> <tr> <td>5 GR/YW</td> <td>Ground</td> <td></td> </tr> </table>	Voltage	12 - 24 DC	100 - 120 AC	Current	80 - 40 mA	60 mA	1 BRN	⊕	L1	3 BLU	⊖	L2	2 WHT	12 - 24 DC	100 - 120 AC	4 BLK	2A	1A	5 GR/YW	Ground		Nitrogen Only: Pcharge = 15 MPa at 20°C TS = 4° - 71°C, PS = 35 MPa
Voltage	12 - 24 DC	100 - 120 AC																					
Current	80 - 40 mA	60 mA																					
1 BRN	⊕	L1																					
3 BLU	⊖	L2																					
2 WHT	12 - 24 DC	100 - 120 AC																					
4 BLK	2A	1A																					
5 GR/YW	Ground																						

This product is Listed to applicable UL Standards and requirements by UL

Reference B10143 for additional information

Cable Accessory	
90.454.M12B.S.____ Attachment Orientation: S = Straight	90.454.M12B.L.____ Attachment Orientation: L = Elbow
Cable Length: 02 = 2 m, 05 = 5 m, 10 = 10 m	

Ordering Example:

90.406.421. B.

Plate Style

B= English plate style

*For Japanese plate order 90.406.421. A.

Fitting Location

B, C, D, BD

<ul style="list-style-type: none"> Output: SPST N.O. (Normally Open) Supply Voltage: 12 – 24 VDC, 80 – 130 VAC (50 – 60 Hz) 	<ul style="list-style-type: none"> Max Pressure Rating: 350 bar (5076 psi) Electrical Connection: M12 (B – Code), 5 Wire, Reverse Key
---	---

Tools for Hose Assembly Construction

DADCO carries a variety of tools for Hose Assembly Construction, please refer to bulletin B11110A for more information on the selection shown below.

Hose Cutter

Used to cut hose to appropriate length. The 90.320.7 works with all hose sizes.



Mini Hose Cutter
90.320.7

Hose Assembly Clamp

Used to secure hose while installing hose adapters. The 90.320.9 is for use with the 90.700 / 90.705 (Y-700 / Y-705) hoses, and the 90.320.6 is compatible with all hose sizes.

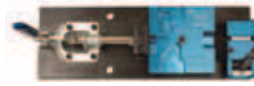

Mini Hose Assembly Clamp
90.320.9



Hose Assembly Clamp
90.320.6 (HAC)

Portable Crimping Unit 90.720

Used with appropriate die ring to create permanent hose assemblies. For more information, request bulletin B04112A.



Mini-Crimp 90.710.8

Used in a crimping machine to construct hose assemblies using 90.700 / 90.705 (Y-700 / Y-705) hose.

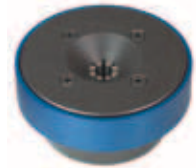

Crimp Dies

Used in Portable Crimping Unit to construct hose assemblies. For information on constructing hose assemblies, refer to bulletin B00120C.

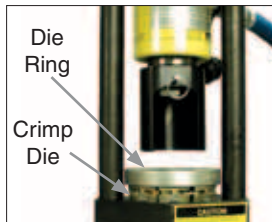

Part No.	Crimp Die	Crimp Diameter mm / inch
90.700 / 90.705 (Y-700 / Y-705)	Mini-Crimp 90.710.8 No Ring Required	7.00 – 7.25 .276 – .285
90.500 (Y-500)	80C-P03 Gray Die 82C-R01 Ring	12.19 – 12.70 .480 – .500
90.400 (Y-400)	80C-P04 Red Die 82C-R01 Ring	14.22 – 14.73 .560 – .580
90.250 (Y-250)	80C-P04J Red Die 82C-R01 Ring	13.59 – 14.10 .535 – .555

Using DADCO's Mini-Crimp

1. Place the Mini-Crimp 90.710.8 into the crimping machine. No die ring is required.
2. Insert the hose assembly from below through the center of the Mini-Crimp (F.1). For instructions on constructing a Mini Hose Assembly request bulletin B11110A.
3. Activate the hydraulic or pneumatic crimping machine to permanently crimp fitting to the hose (F.1).

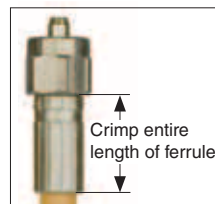

4. As the DADCO Mini-Crimp begins to close, position the fitting to ensure the entire length of the ferrule is crimped (F.2).

5. Remove completed hose assembly from the Mini-Crimp.

6. Measure the crimped ferrule diameter across the flats to verify it is within the crimp dimension range (F.3).

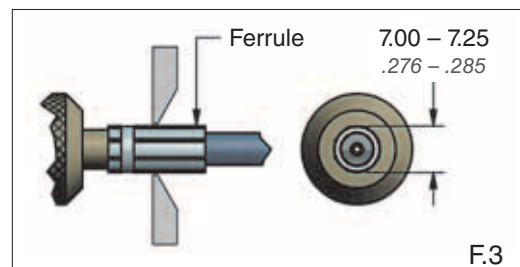
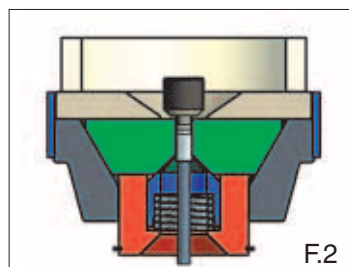
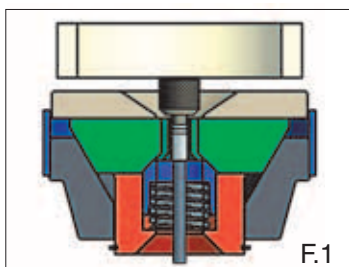

Charging Accessories

Quick Disconnect Charging Hardware

Use the DADCO Quick Disconnect Charging Assembly, 90.310.040, with the 90.310.143 or 90.310.111 Charging Nipple or the 90.315.5 Pressure Analyzer to charge self-contained gas springs. The 90.310.040 can also be used with a DADCO control panel to charge linked systems.

The 90.310.044 Quick Disconnect Filling Assembly with self-venting capabilities releases residual pressure after charging self-contained or linked nitrogen gas spring systems for easy decoupling between the filling assembly and charging nipple or filler valve.

DADCO also offers the 90.310.041 High Pressure Charging Assembly to charge Micro Series, SCR Series and U.0175 – U.0400 nitrogen gas springs to maximum pressure.



Quick Disconnect Filling Assembly with Gauge, 90.310.339, is also available.

90.310.040

Standard Pressure Regulator 90.310.201



Hose Assembly 90.310.252
3 m / 10 ft

Quick Disconnect Filling Assembly 90.310.338

90.310.044 (Self-Venting)

Standard Pressure Regulator 90.310.201

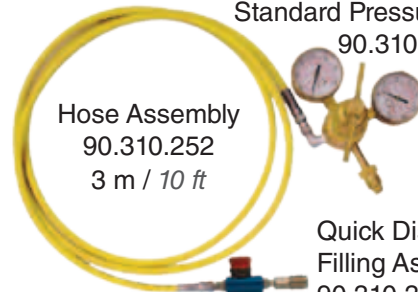

Hose Assembly 90.310.252
3 m / 10 ft

Quick Disconnect Filling Assembly 90.310.340*

*Not recommended with 90.416.A2B or 90.406.421

Quick Disconnect Charging Nipple

90.310.143 (M6 Port)

90.310.111 (G 1/8 Port)



90.310.143

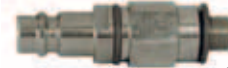

90.310.111

Use the appropriate Quick Disconnect Charging Nipple to charge DADCO Nitrogen Gas Springs. For additional information request bulletin B01122C.

Safety Plates

DADCO recommends customers identify tools containing high pressure nitrogen gas springs to ensure proper handling of the cylinders. DADCO offers several caution tags to meet specific application needs. For more information request bulletin B01103A.



Compact Nitrogen Gas Booster DGB.100

DADCO's Compact Nitrogen Gas Booster System, DGB.100, is a lightweight, cost-effective way to extend the life of your nitrogen supply tanks. Using the DGB.100, tanks with low pressure can be boosted to a higher pressure that is suitable for charging the gas spring. For more information refer to bulletin B13105.



Nitrogen Gas Booster System DGB.150

DADCO's Nitrogen Gas Booster System, DGB-150, is an all-in-one solution to the problems of low pressure supply tanks and lost nitrogen gas during discharge. For more information on the booster, refer to bulletin B07101.



Complete Linked System Solutions



DADCO®

The global leader in nitrogen gas spring technology

Printed in USA

©DADCO, Inc. 2016 All Rights Reserved

Product changes may occur during the life of this catalog without prior notice, but products supplied will remain functionally interchangeable.